

# INSTRUCTION MANUAL

## 1/10 Scale 2WD Electric Buggy



# INSTRUCTION MANUAL

## 1/10 Scale 2WD Electric Buggy

**RH2011 Bullet EBD**

**RH2012 Bullet EBL**

Features: 1. Alum motor mount

2. Low CG gearbox design

3. Metal diff gear design

4. Front and rear sway bar

5. water proof receiver box

6. adjustable ground clearance

7. Big bored oil filled shocks

8. Alum chassis with mud plates

9. Slipper system (for brushless only)

Specs.:

1. Length: 380 mm
2. Width: 250 mm
3. Height: 130 mm
4. Wheelbase: 272-275 mm
5. Gear Ratio: 8.1:1
6. Weight: 1500g

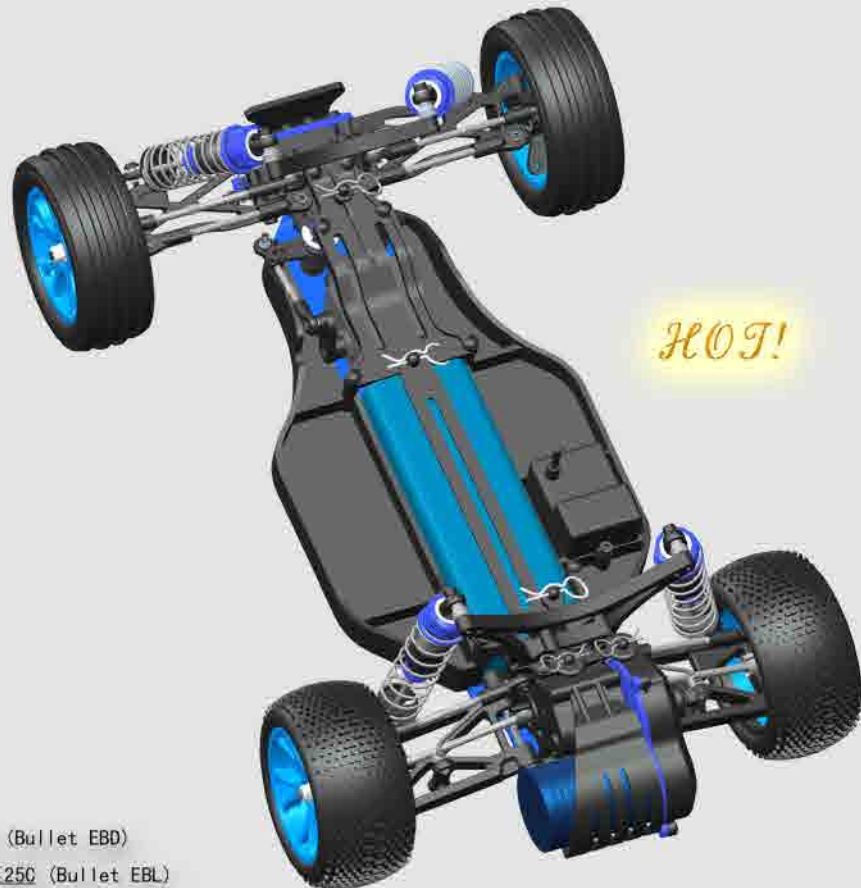

Standard Equipments:

1. Steering Servo: 3kg/cm
2. Motor: 540 (Bullet EBD)  
3650 (Bullet EBL)
3. ESC: 300A (Bullet EBD)  
45A (Bullet EBL)
4. Battery: Ni-MH SC1800mAh 7.2V (Bullet EBD)  
Li-Po 3250mAh 7.4V  $\leq 25C$  (Bullet EBL)
5. RADIO: 2CH A M (Bullet EBD)  
2CH 2.4GHz (Bullet EBL)

**Bullet EBL Brushless System Set:**

**Bullet EBD Brushed System Set:**



# FRONT & REAR SHOCK ASSEMBLY

## Front Shocks

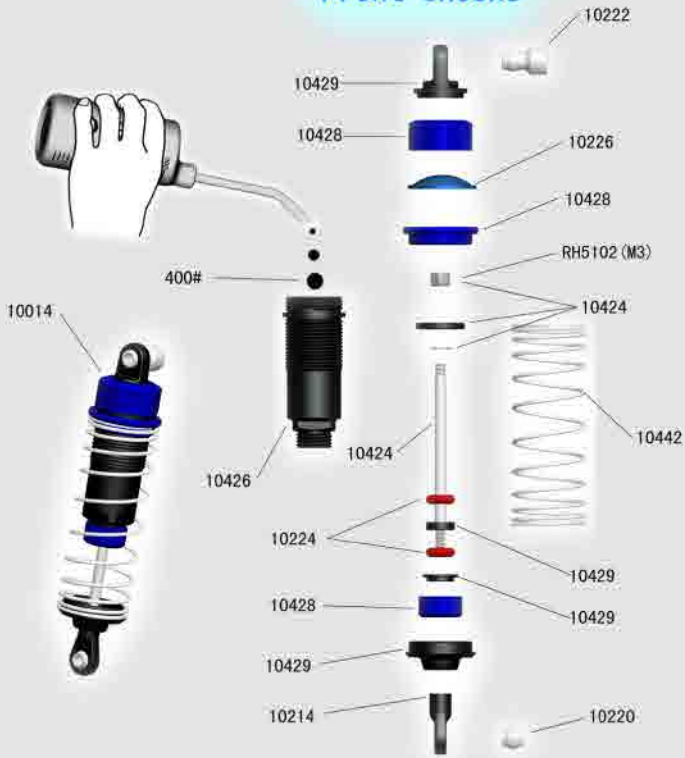

(Dia. 3-1)

## Rear Shocks

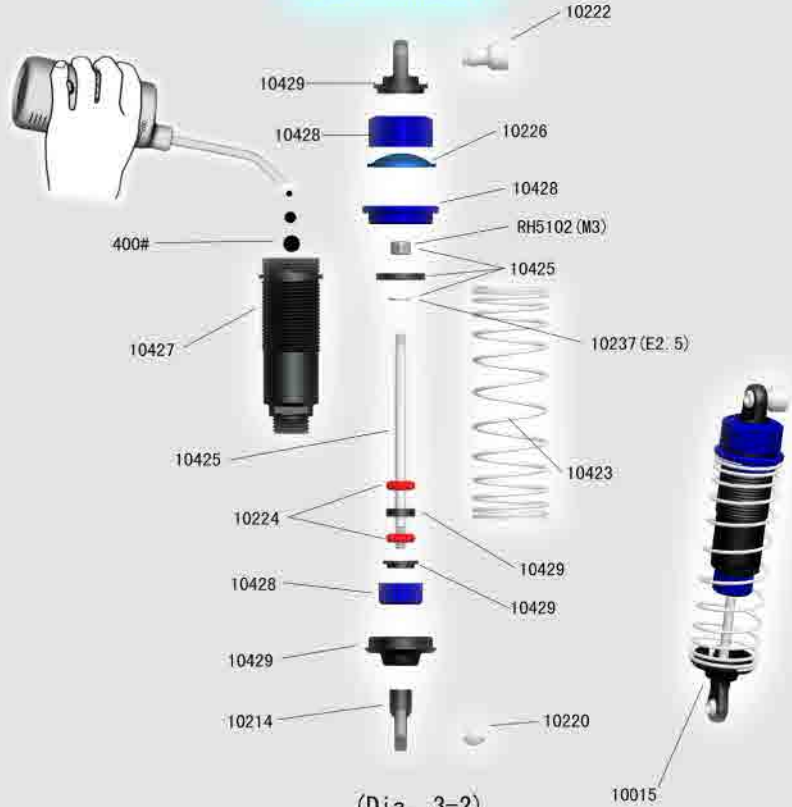

(Dia. 3-2)

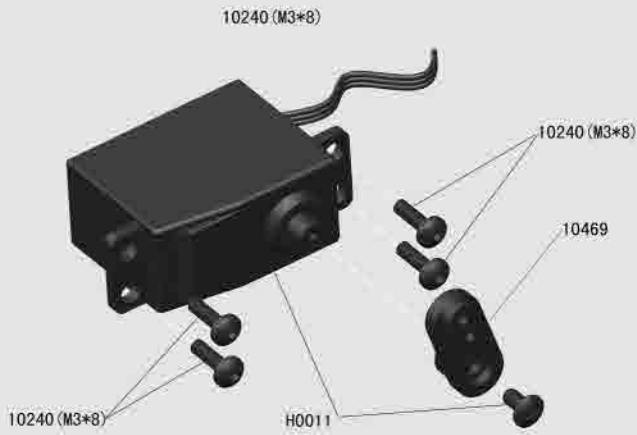

## Steering Servo



(Dia. 3-3)

## FRONT Tyres

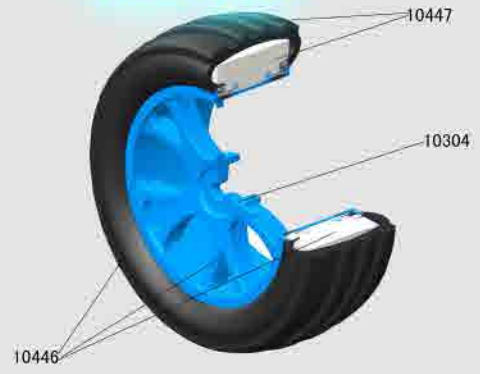

(Dia. 3-4)

## Rear Tyres

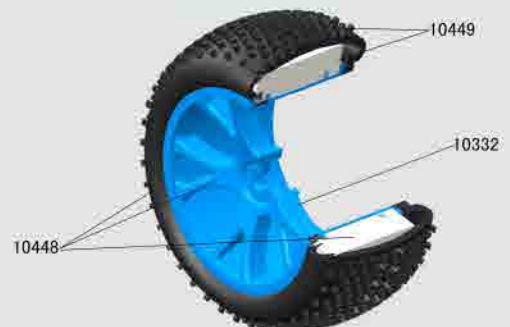

(Dia. 3-5)





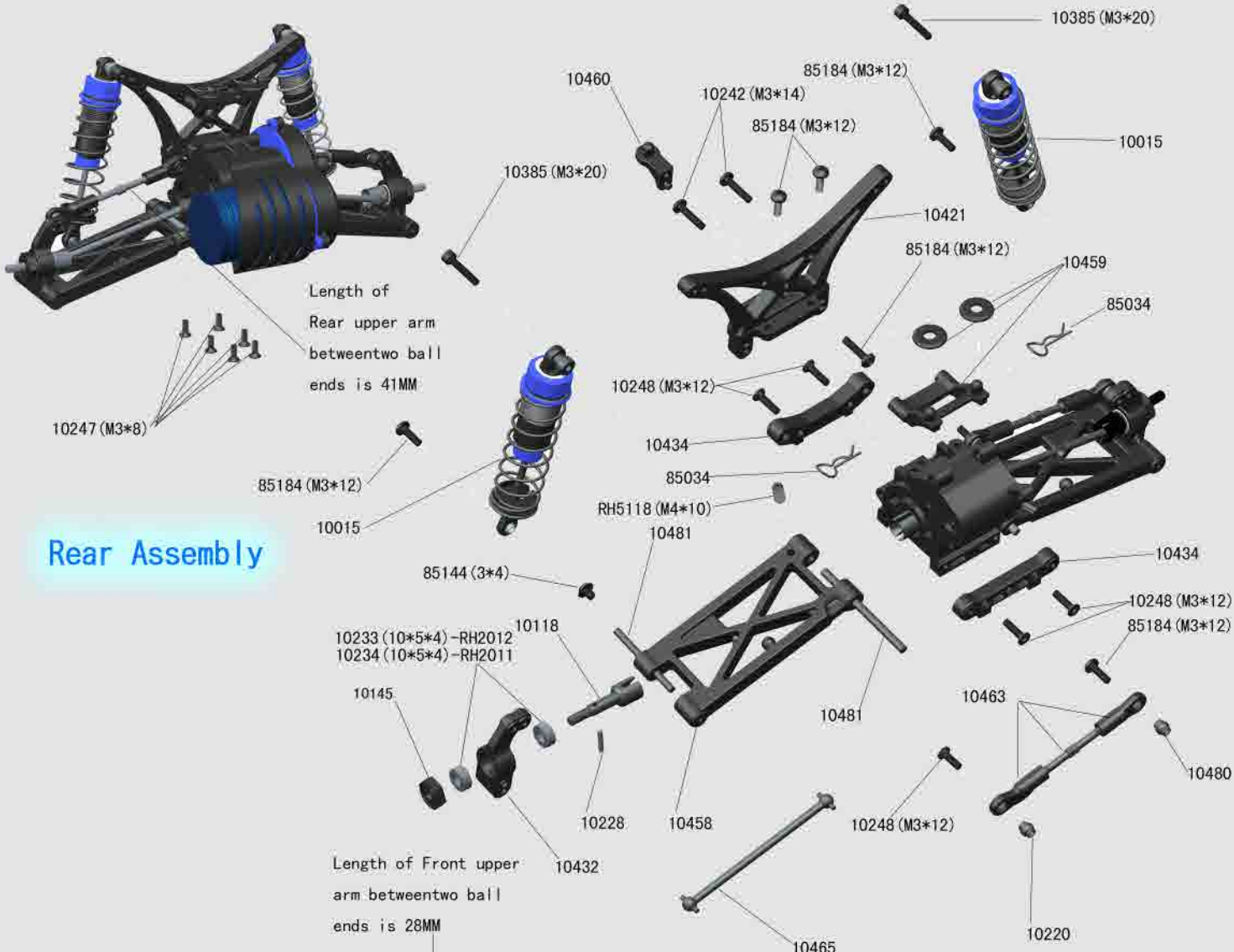

Rear Assembly

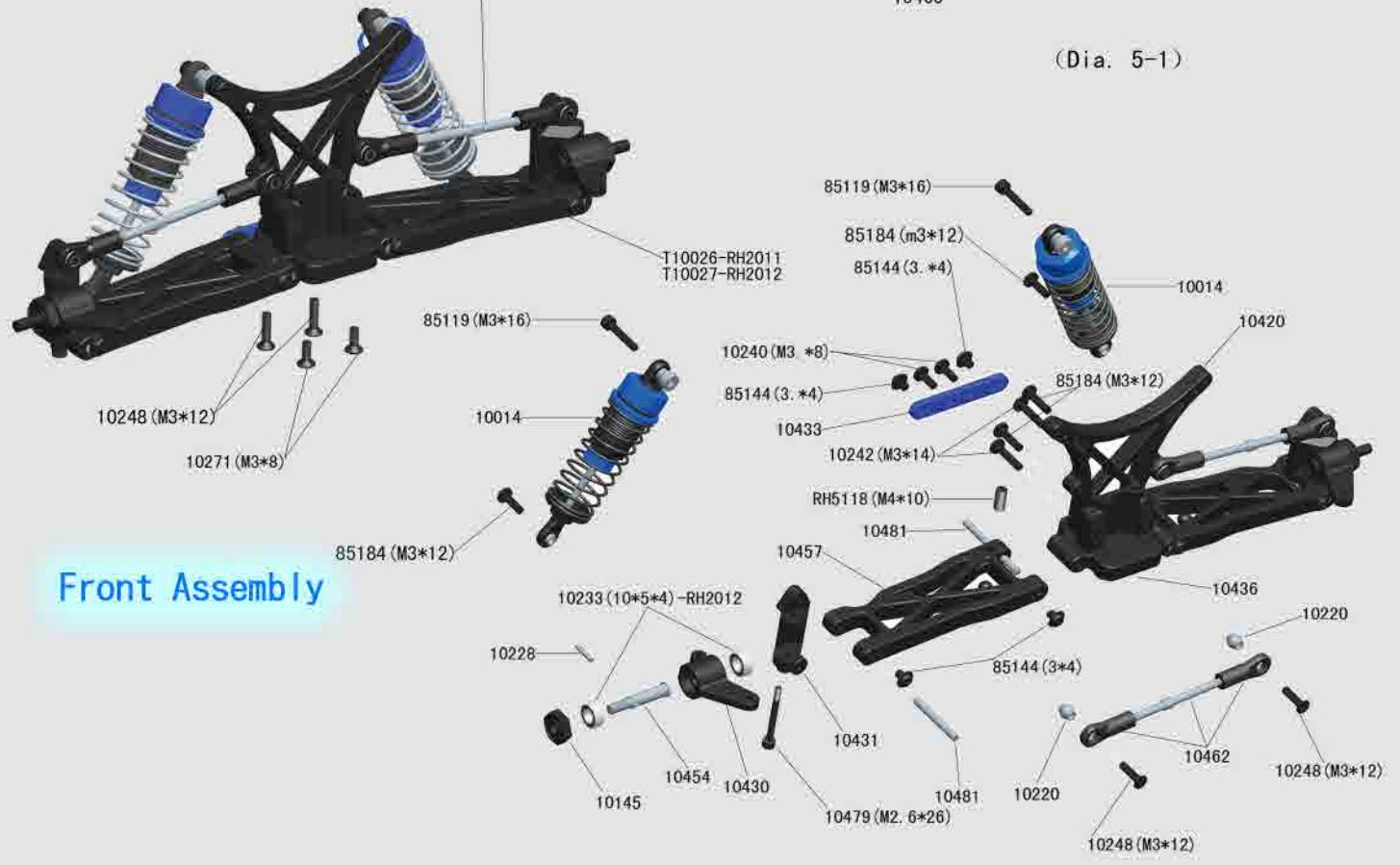

Front Assembly





# ASSEMBLY STEPS:

1. Assembly center chassis part (See Dia. 6-1)

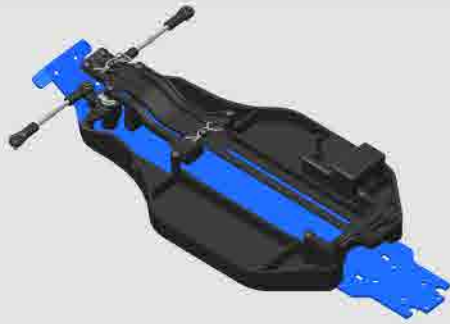

2. Assemble front assembly to chassis front. (See Dia. 5-2)

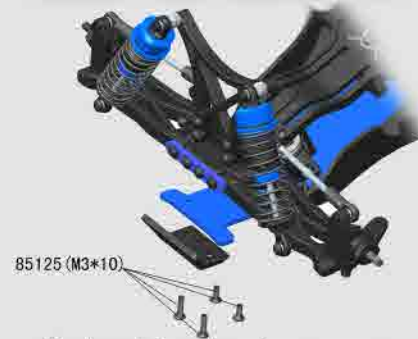

3. Assemble rear assembly to chassis rear part. (See Dia. 4-1, 4-2, 5-1)

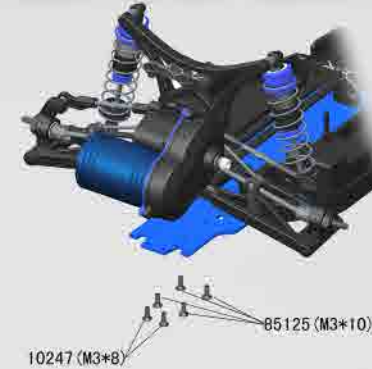

4. Mount the wheels. (See Dia. 3-4, 3-5, 6-4)



5. Assemble steering servo and linkage. (See Dia. 3-3)

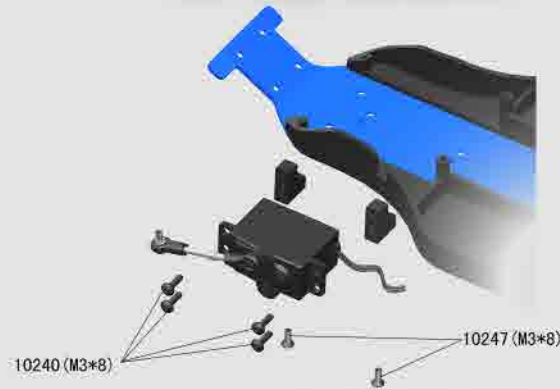

8. Assemble ESC, receiver, battery and connect them to setup. (See Dia. 7-3, 7-5)

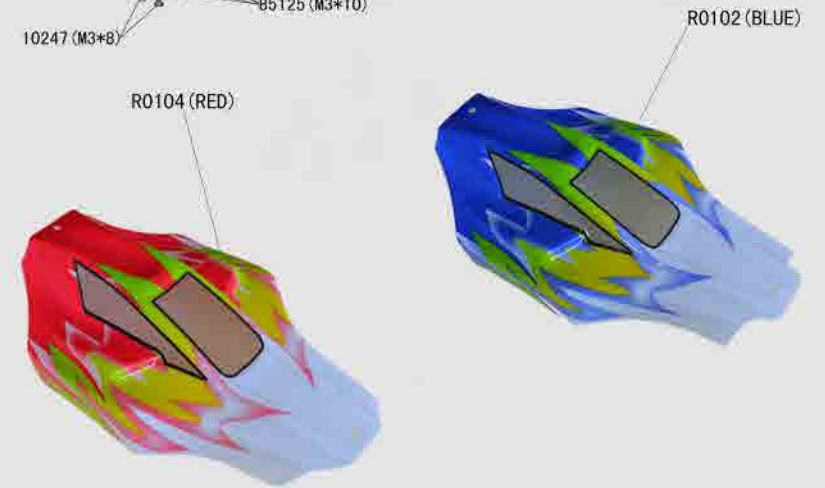

R0105 (RED)  
R0103 (BLUE)

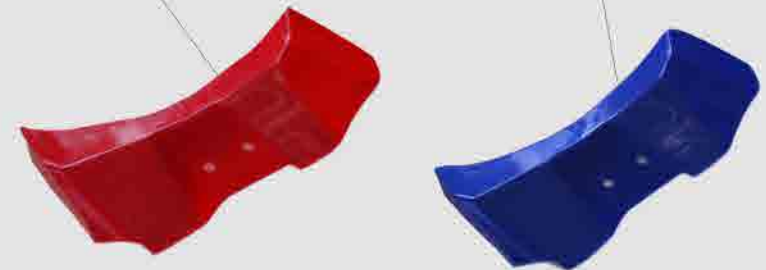

## Brushless System:

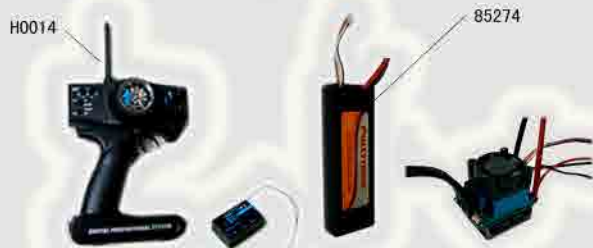

## Brushed system:



























# Common Part List

















<p>10420-Front Shock Tower 1pc</p>  <p>RH2011/RH2012</p>	<p>10421-Rear Shock Tower 1pc</p>  <p>RH2011/RH2012</p>	<p>10014-Front Shocks 2pcs</p>  <p>RH2011/RH2012</p>	<p>10015- Rear Shocks 2pcs</p>  <p>RH2011/RH2012</p>
<p>10422-Front Shock Spring 2pcs</p>  <p>RH2011/RH2012</p>	<p>10423-Rear Shock Spring 2pcs</p>  <p>RH2011/RH2012</p>	<p>10424-Front Shock Shaft &amp; Piston Set 2sets</p>  <p>RH2011/RH2012</p>	<p>10425-Rear Shock Shaft &amp; Piston Set 2sets</p>  <p>RH2011/RH2012</p>
<p>10426-Front Shock Body 2pcs</p>  <p>RH2011/RH2012</p>	<p>10427-Rear Shock body 2pcs</p>  <p>RH2011/RH2012</p>	<p>10428-Shock Cap&amp;Adjust Ring 2sets</p>  <p>RH2011/RH2012</p>	<p>10429-Shock Lower holder 2sets</p>  <p>RH2011/RH2012</p>
<p>10146-Antenna Pipe Set 2sets</p>  <p>RH2011/RH2012</p>	<p>10430-Steering Knuckle Arm 1set</p>  <p>RH2011/RH2012</p>	<p>10431-Uprights 2pcs</p>  <p>RH2011/RH2012</p>	<p>10432-Rear Hub Carrier 2pcs</p>  <p>RH2011/RH2012</p>
<p>10118-Rear Drive Shaft 2pcs</p>  <p>RH2011/RH2012</p>	<p>10433-Front Susp. Holders 1pc</p>  <p>RH2011/RH2012</p>	<p>10434-Rear Susp. Holders 2pcs</p>  <p>RH2011/RH2012</p>	<p>10435-Gearbox Housing Set 2pcs</p>  <p>RH2011/RH2012</p>
<p>10436-Front shock tower holder 1pc</p>  <p>RH2011/RH2012</p>	<p>10476-Slipper Spring Bracket 1pc</p>  <p>RH2012</p>	<p>10016-Diff Gearbox Set 1set</p>  <p>RH2011/RH2012</p>	<p>10437-Diff Case 2pcs</p>  <p>RH2011/RH2012</p>























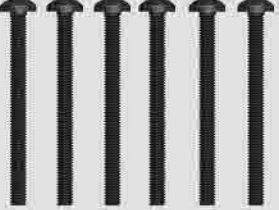

# Common Part List

<p>10438-19T Gear 1pc</p>  <p>19T</p> <p>RH2011/RH2012</p>	<p>10439-13T Gear 1pc</p>  <p>13T</p> <p>RH2011/RH2012</p>	<p>10128-Diff Bevel Gear S: 4pcs</p>  <p>10T</p> <p>RH2011/RH2012</p>	<p>10129-Diff Bevel Gear B: 4pcs</p>  <p>13T</p> <p>RH2011/RH2012</p>
<p>10130-Diff Pin 2pcs</p>  <p>RH2011/RH2012</p>	<p>10440-Gear shaft 1pc</p>  <p>RH2011/RH2012</p>	<p>10132-Diff Drive Cup 4pcs</p>  <p>RH2011/RH2012</p>	<p>10441-Rear top deck 1pc</p>  <p>RH2011/RH2012</p>
<p>10442-Motor Mount 1pc</p>  <p>RH2011/RH2012</p>	<p>10136-Servo Saver Post 2pcs</p>  <p>RH2011/RH2012</p>	<p>10443-Steering Ackerman 1set</p>  <p>RH2011/RH2012</p>	<p>10145-Wheel Hub 4pcs</p>  <p>RH2011/RH2012</p>
<p>10192-Slipper Pad 2pcs</p>  <p>RH2012</p>	<p>10445-Servo Saver 1set</p>  <p>RH2011/RH2012</p>	<p>10446-Front buggy tyre set 2sets</p>  <p>RH2011/RH2012</p>	<p>10447-Front tyres &amp; inner foams 2sets</p>  <p>RH2011/RH2012</p>
<p>10448-Rear buggy tyre set 2sets</p>  <p>RH2011/RH2012</p>	<p>10449-Rear tyres &amp; inner foams 2sets</p>  <p>RH2011/RH2012</p>	<p>10304-Front Rim 2pcs 10332-Rear Rim 2pcs</p>  <p>RH2011/RH2012</p>	<p>10450-Upper plate 1pc</p>  <p>RH2011/RH2012</p>
<p>10451-Battery Cover 1pc</p>  <p>RH2011/RH2012</p>	<p>10452-Chassis mud guard(L) 1pc</p>  <p>RH2011/RH2012</p>	<p>10453-Chassis mud guard(R) 1pc</p>  <p>RH2011/RH2012</p>	<p>10454-Front drive shaft 2pcs</p>  <p>RH2011/RH2012</p>

# Part List

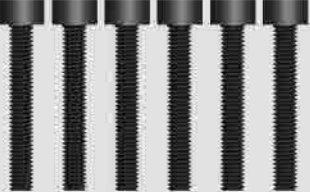



















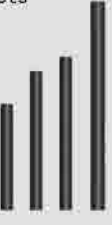

<p>10455-Motor cover 1pc</p>  <p>RH2011/RH2012</p>	<p>10456-Front Bumper 1pc</p>  <p>RH2011/RH2012</p>	<p>10457-Front Lower Susp. Arm 2pcs</p>  <p>RH2011/RH2012</p>	<p>10458-Rear Lower Susp. Arm 2pcs</p>  <p>RH2011/RH2012</p>
<p>10459-Wing Holder 1set</p>  <p>RH2011/RH2012</p>	<p>10460-Buggy Body Mount 1set</p>  <p>RH2011/RH2012</p>	<p>10461-Servo Linkage 1set</p>  <p>RH2011/RH2012</p>	<p>10462-Front Upper Susp. Arm 2sets</p>  <p>RH2011/RH2012</p>
<p>10463-Rear Upper Susp. Arm 2sets</p>  <p>RH2011/RH2012</p>	<p>10464-Steering Arm 2sets</p>  <p>RH2011/RH2012</p>	<p>10465-Rear Dogbone 2pcs</p>  <p>RH2011/RH2012</p>	<p>10466-Chassis Plate 1pc</p>  <p>RH2011/RH2012</p>
<p>10467-Gear cover 1pc</p>  <p>RH2011/RH2012</p>	<p>10468-Receiver Box 1set</p>  <p>RH2011/RH2012</p>	<p>10469-Servo Horn 1pc</p>  <p>RH2011/RH2012</p>	<p>10470-Servo post 2pcs</p>  <p>RH2011/RH2012</p>
<p>10471-Slipper shaft (EBL) 1pc</p>  <p>RH2012</p>	<p>10228-Pin <math>\phi</math>2*10 6pcs</p>  <p>RH2011/RH2012</p>	<p>10193-Slipper Gasket 2pcs</p>  <p>RH2012</p>	<p>10472-70T Spur Gear 1pc (Brushed) 10484-70T Spur Gear 1pc (Brushless)</p>  <p>RH2011/RH2012</p>
<p>RH5107-E clip-3mm 6pcs</p> 	<p>10474-Slipper Spring 1pc</p>  <p>RH2012</p>	<p>10475-Slipper shaft (EBD) 1pc</p>  <p>RH2011</p>	<p>10323-Pinion Gear 23T 1pc</p>  <p>RH2011/RH2012</p>

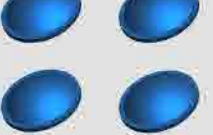
# Part List

<p>10236-E clip-8mm 4pcs</p> 	<p>10237-E clip-2.5mm 6pcs</p> 	<p>RH5103-Nylon Lock Nut-M4 6pcs</p> 	<p>RH5102-Nylon Lock Nut-M3 6pcs</p> 
<p>10239-Round Head Self Tapping Hex Screw M3*6 6pcs</p> 	<p>10238-Round Head Self Tapping Hex Screw 2*10 6pcs</p> 	<p>10240-Button Head Hex Screw M3*8 6pcs</p> 	<p>10241-Button Head Hex Screw M3*10 6pcs</p> 
<p>85184-Button Head Hex Screw M3*12 6pcs</p> 	<p>10242-Button Head Hex Screw M3*14 6pcs</p> 	<p>10477-Button Head Hex Screw M3*30 6pcs</p> 	<p>10478-Button Head Hex Screw M3*34 6pcs</p> 
<p>85144-Ring Self Tapping Screw 3*4 4pcs</p> 	<p>RH5117-Set Screw M4*4 6pc</p> 	<p>RH5118-Button Head Hex Screw M4*10 6pcs</p> 	<p>10479-Cap Head Hex Screw M2.6*26 6pcs</p> 
<p>RH5562-Cap Head Hex Screw M3*8 6pcs</p> 	<p>10244-Cap Head Hex Screw M3*14 6pcz</p> 	<p>85119-Cap Head Hex Screw M3*16 6pcs</p> 	<p>10385-Cap Head Hex Screw M3*20 6pcs</p> 
<p>10247-Flat Head Hex M3*8 6pcs</p> 	<p>85125-Flat Head Hex M3*10 8pcs</p> 	<p>10248-Flat Head Hex M3*12 6pcs</p> 	<p>85186-Washer <math>\phi</math> 6*<math>\phi</math> 3.1*0.5 6pcs</p> 



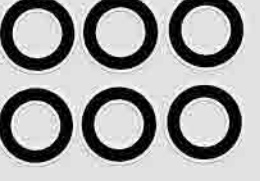









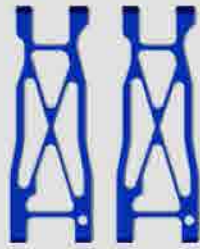
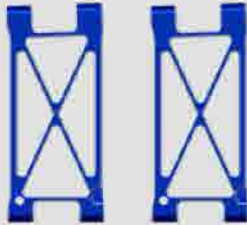

# Part List

<p>85034-Body Clip(Medium Size) 6pcs</p> 	<p>85029-Body Clip(Small Size) 6pcs</p> 	<p>10214-Shock Ball End 6pcs</p> 	<p>10215-Servo Link Ball End 6pcs</p> 
<p>10216-Steering Linkage Ball End 6pcs</p> 	<p>10217-Rear Upper Linkage Ball End 6pcs</p> 	<p>10219-Sway Bar Holders 6pcs</p> 	<p>10482-Sway bar holder 1pc</p> 
<p>10220-Ball A 6pcs</p> 	<p>10222-Ball C 6pcs</p> 	<p>10480-Ball D 6pcs</p> 	<p>10223-Ball E 6pcs</p> 
<p>10481-Hinge Pins (long &amp; short) 1sets</p> 	<p>10224-Shock O-ring(Lower) 6pcs</p> 	<p>10225-Diff O-ring Seal 6pcs</p> 	<p>10226-Shock seal cover 4pcs</p> 
<p>10153-Metal Bushing 8*5*2.5 6pcs</p> 	<p>10152-Metal Bushing 15*10*4 6pcs</p> 	<p>10234-Metal Bushing 10*5*4 6pcs</p> 	<p>10235-Ball Bearing 8*5*2.5 6pcs</p> 
<p>10232-Ball Bearing 15*10*4 6pcs</p> 	<p>10233-Ball Bearing 10*5*4 6pcs</p> 	<p>10386-Pin <math>\phi</math>2*8 6pcs</p> 	<p>H0011 - 3kg/cm Servo 1pc</p> 

# Part List

<p>10253 - 1/10 Charger CE 1pc 10254 - 1/10 Charger UL 1pc 10255 - 1/10 Charger BS 1pc</p> 	<p>H0013-AM Transmitter 1pc H0007-AM RX 1pc</p> 	<p>H0014 - 2.4GHz Transmitter 1pc</p> 	<p>H0026 - Brushless ESC 1pc</p> 
<p>H0027-300A ESC 1pc</p> 	<p>H0028 - 3650 Brushless Motor 1pc</p> 	<p>H0048 - 540 Brushed Motor 1pc</p> 	<p>H0030 - Ni-MH 7.2V 1800mAh 1pc H0031 - Ni-MH 7.2V 3000mAh 1pc</p> 
<p>85274-Li-Po 3250mAh 7.4V 1pc</p> 	<p>H0050 -400A ESC 1pc</p> 	<p>H0049 -3kg/cm Servo 1pc</p> 	<p>R0102-Printed Body (BLUE) 1pc</p> 
<p>R0103 -Wing (BLUE) 1pc</p> 	<p>R0104 -Printed Body (RED) 1pc</p> 	<p>R0105 -Wing (RED) 1pc</p> 	

# Upgrade Parts List

<p>10934 -Sway Bar 1set</p>  <p>RH2011/RH2012</p>	<p>10935-Upper plate (AL) 1set</p>  <p>RH2011/RH2012</p>	<p>10936-Front shock tower holder (AL) 1pc</p>  <p>RH2011/RH2012</p>	<p>10937-Uprights (AL) 1set</p>  <p>RH2011/RH2012</p>
<p>10938-Steering Knuckle Arm (AL) 1set</p>  <p>RH2011/RH2012</p>	<p>10939-Front Lower Susp. Arm (AL) 2pcs</p>  <p>RH2011/RH2012</p>	<p>10940-Rear Lower Susp. Arm (AL) 2pcs</p>  <p>RH2011/RH2012</p>	<p>10941-Battery Cover 1pc</p>  <p>RH2011/RH2012</p>
<p>10942- Front Shock Tower (AL) 1pc</p>  <p>RH2011/RH2012</p>	<p>10943-Rear Shock Tower (AL) 1pc</p>  <p>RH2011/RH2012</p>	<p>10944-Front Shocks (AL) 2pcs</p>  <p>RH2011/RH2012</p>	<p>10945-Rear Shocks (AL) 2pcs</p>  <p>RH2011/RH2012</p>
<p>10946-Rear Susp. Holders (AL) 2pcs</p>  <p>RH2011/RH2012</p>	<p>10947-Rear top deck (AL) 1pc</p>  <p>RH2011/RH2012</p>	<p>10915 - Rear Hub Carrier (AL) 2pcs</p>  <p>RH2011/RH2012</p>	